



ENCLOSED SWITCHGEAR

POLYCARBONATE ROTARY ENCLOSED SWITCH DISCONNECTOR 4 POLE IS1004

General Characteristics

Standards	EN60947-3
Rated Current	100A
No.of Poles	4
Rated Insulation Voltage(V)	690V
Rated Operating Current(A)	100
AC-22A	100
AC-23A	100
AC-3	80
Rated Voltage(Ue)	440V
Rated Power Control(KW)	37
Rated short-time withstand current(Icw)	2000A
Connect Wire	35mm ²
Screw Torque	2 N.m

Enclosure Characteristics

Overall Dimensions HxWxD	240x160x122mm
Depth with switch	150.5mm
Degree of IP	IP65
Colour	Upper cover RAL9002, Bottom case RAL 7031

Wiring Diagram

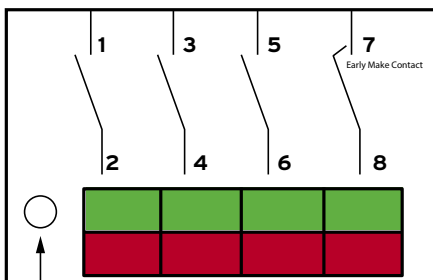

Note 7 = Early Make Contact

Technical Drawing

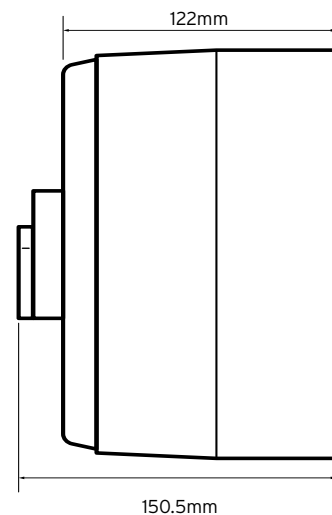
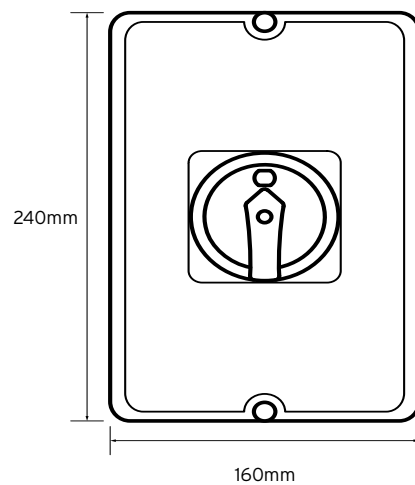

Additional Information

This product is for use by skilled persons or instructed persons. The installation of this product must comply with current IEE regulations. The IP rating of the unit can be compromised if the correct use of glands is not followed. Terminals, including those factory fitted, must be checked for correct tightness before commissioning. All terminals should be periodically checked for correct tightness. The data herein serves only to describe the product and should not be regarded as representing guaranteed properties in the legal sense. We reserve the rights of modification, whilst every care has been taken in ensuring the accuracy of this catalogue, the Supplier accepts no liability whatsoever for any eventuality arising from errors or omissions within its catalogues, brochures or within any online presence.